

DIAGRAMMA DI FUNZIONAMENTO
 Performance curves
 POMPA CENTRIFUGA MONOSTADIO
 Monostage centrifugal pump

TIPO
 Type

TCD 50-125



**TRAVAINI
 PUMPS USA**
 Liquid Ring & Rotary Vane Vacuum Pumps and Systems

200 Newsome Drive
 Yorktown, VA 23693
 1-800-535-4243
 www.Travaini.com

I DATI RIPORTATI SONO RIFERITI A :

Data refers to :

TEMPERATURA MAX. 30 °C - (86 °F) Max. Temperature
 PESO SPECIFICO 1 Kg/dm³ Specific gravity
 VISCOSITA' 1 ¨E Viscosity

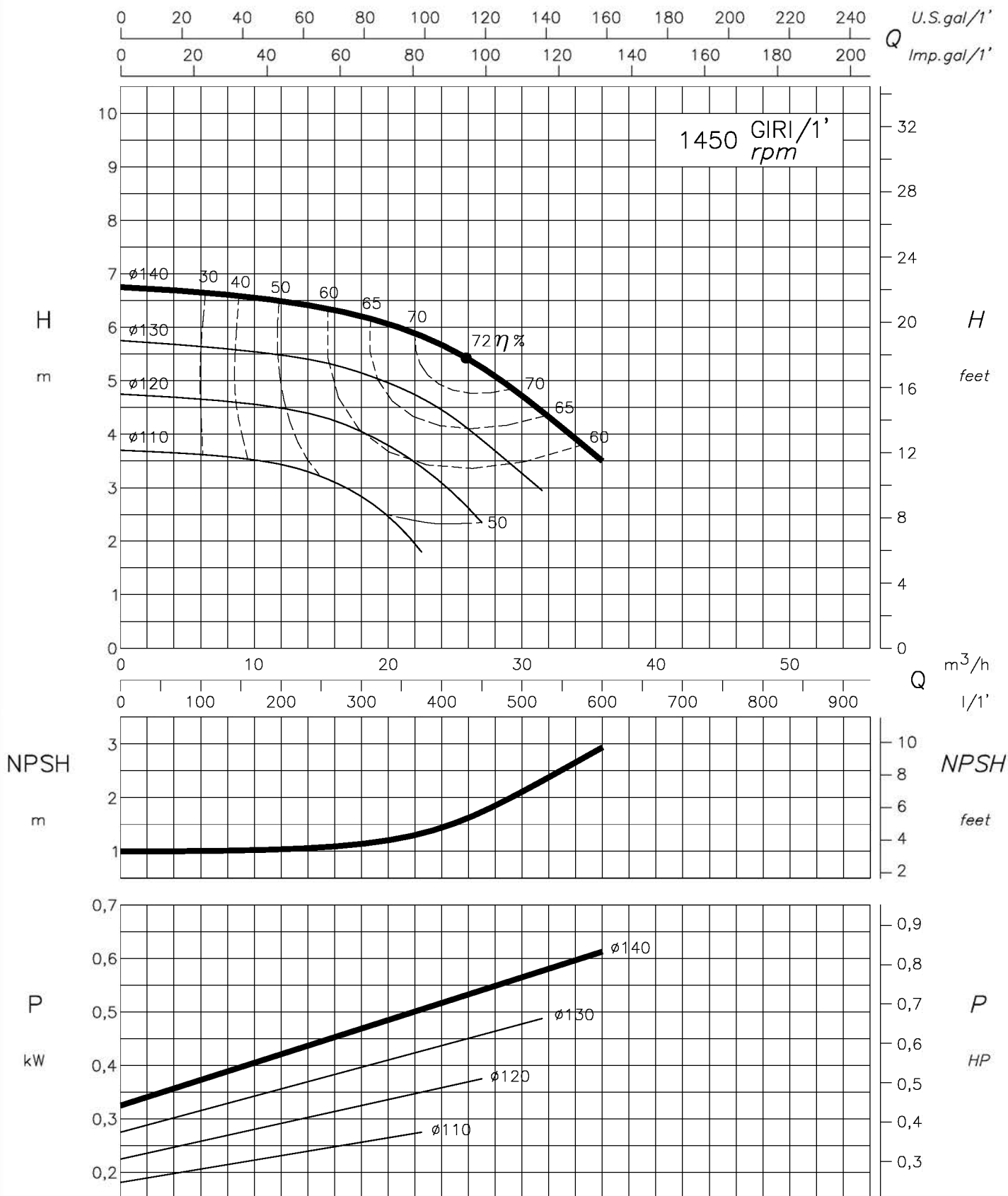



I DATI RIPORTATI SONO RIFERITI A :

Data refers to :
 TEMPERATURA MAX. 30 °C - (86 °F) Max. Temperature
 PESO SPECIFICO 1 Kg/dm³ Specific gravity
 VISCOSITA' 1 cP Viscosity

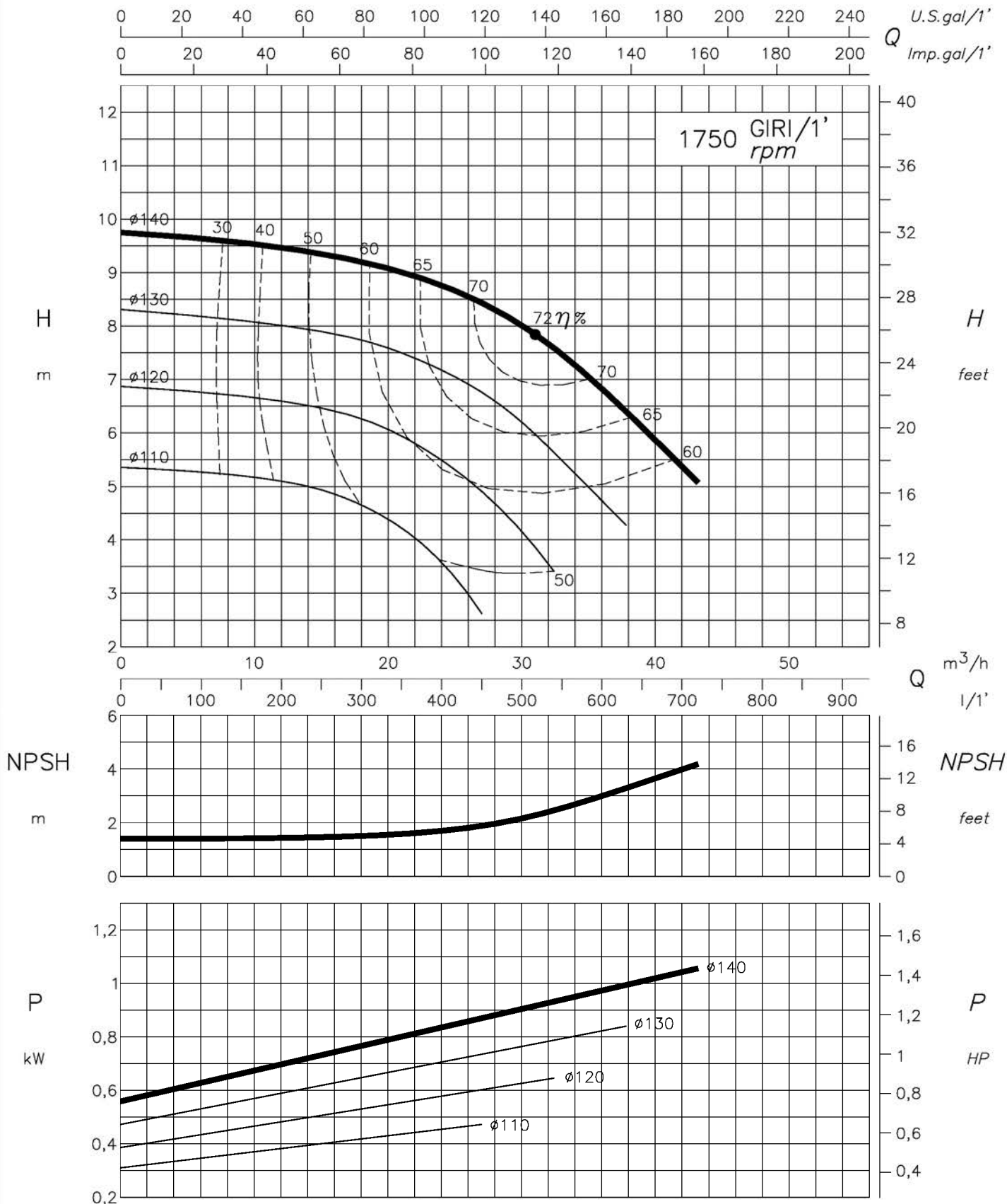



I DATI RIPORTATI SONO RIFERITI A :

Data refers to :

TEMPERATURA MAX. 30 °C - (86 °F) Max. Temperature
 PESO SPECIFICO 1 Kg/dm³ Specific gravity
 VISCOSITA' 1 "E" Viscosity

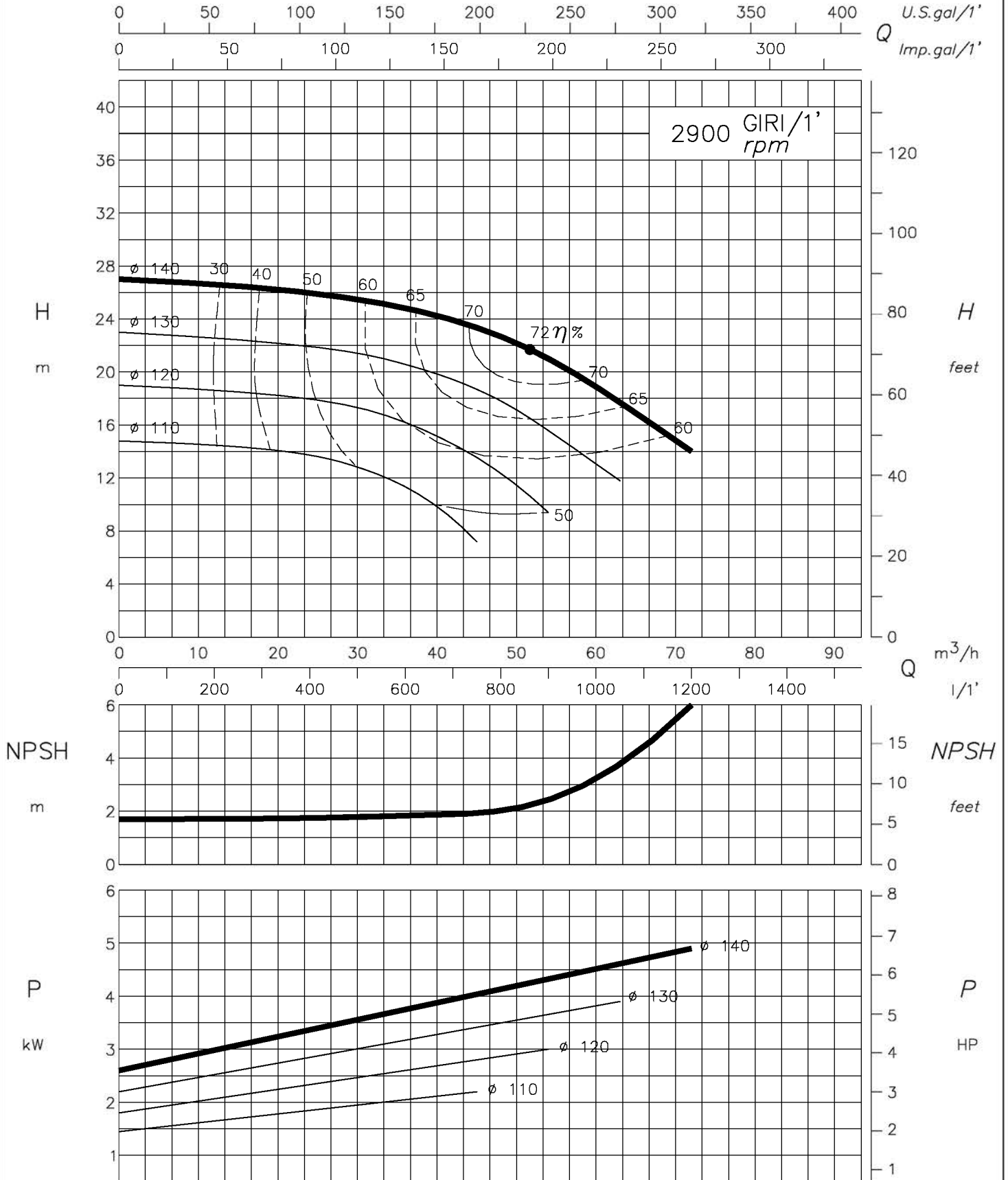



I DATI RIPORTATI SONO RIFERITI A :

Data refers to :

TEMPERATURA MAX. 30 °C - (86 °F) Max. Temperature
PESO SPECIFICO 1 Kg/dm³ Specific gravity
VISCOSITA' 1 cP Viscosity

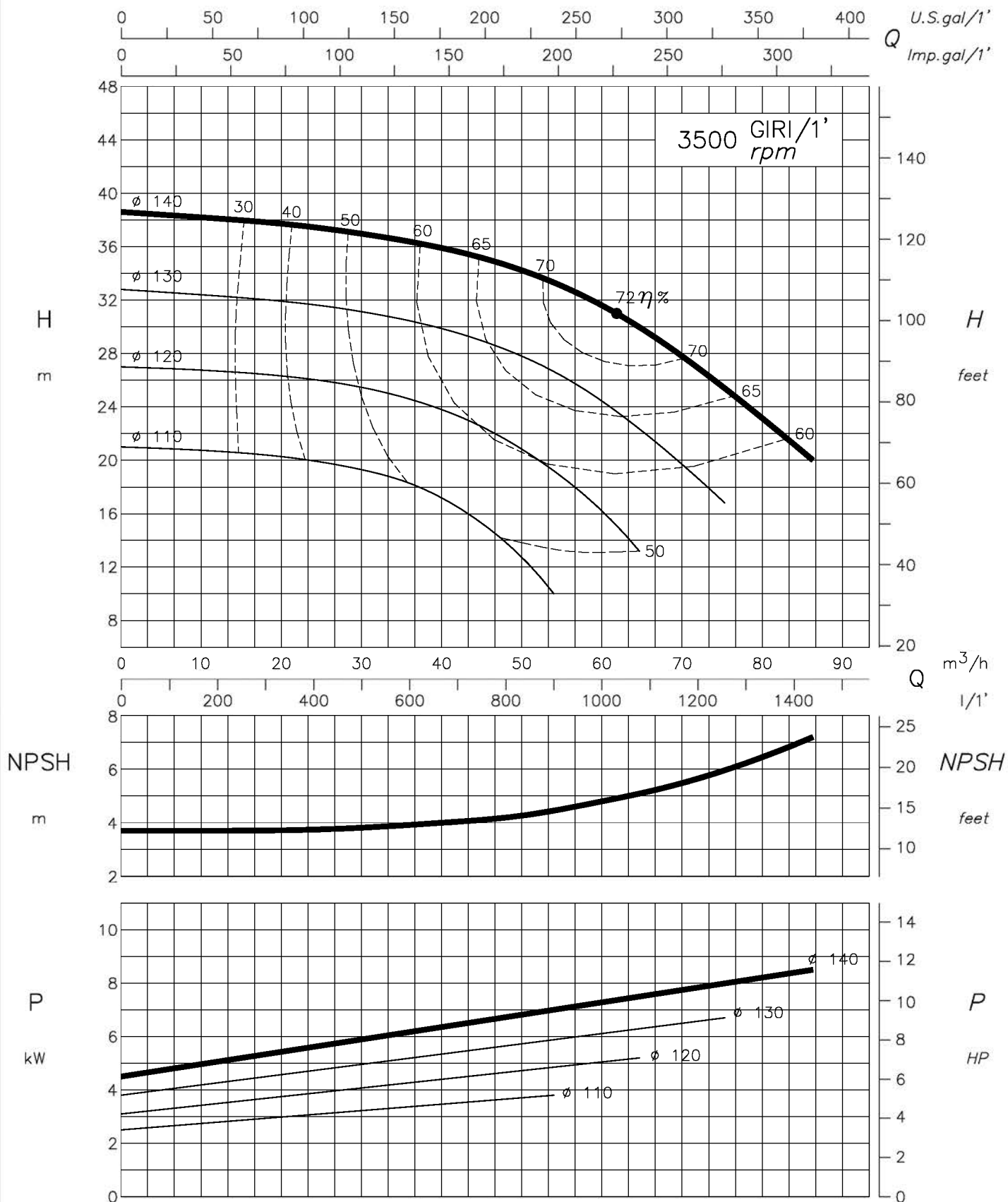



I DATI RIPORTATI SONO RIFERITI A :

Data refers to :
 TEMPERATURA MAX. 30 °C - (86 °F) Max. Temperature
 PESO SPECIFICO 1 Kg/dm³ Specific gravity
 VISCOSITA' 1 ¨E Viscosity



DIAGRAMMA DI FUNZIONAMENTO
 Performance curves
 POMPA CENTRIFUGA MONOSTADIO
 Monostage centrifugal pump

TIPO **TCD 50-160**
 Type

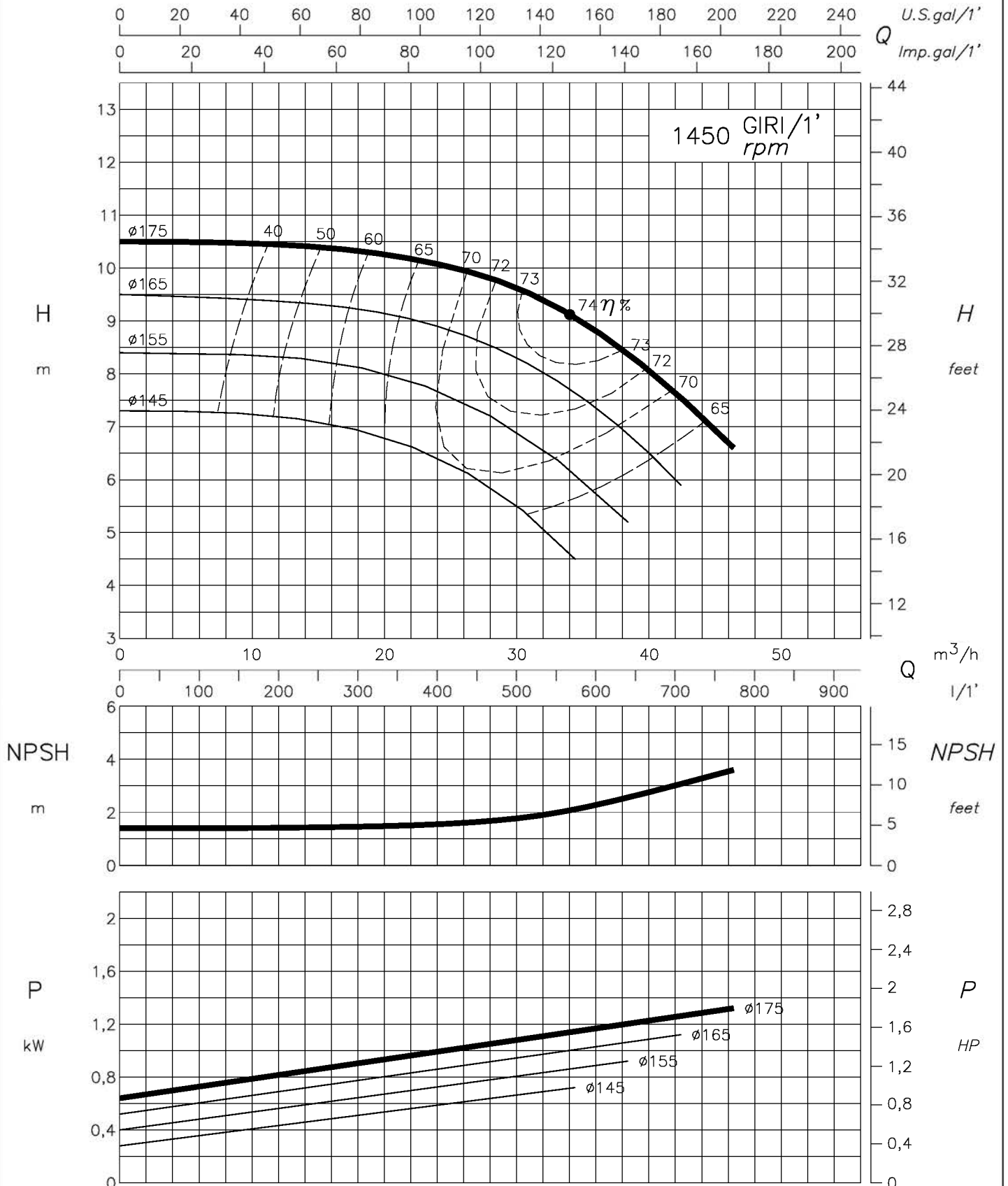

**TRAVAINI
 PUMPS USA**
 Liquid Ring & Rotary Vane Vacuum Pumps and Systems

200 Newsome Drive
 Yorktown, VA 23693
 1-800-535-4243
 www.Travaini.com

I DATI RIPORTATI SONO RIFERITI A :

Data refers to :
 TEMPERATURA MAX. 30 °C - (86 °F) Max. Temperature
 PESO SPECIFICO 1 Kg/dm³ Specific gravity
 VISCOSITA' 1 cP Viscosity

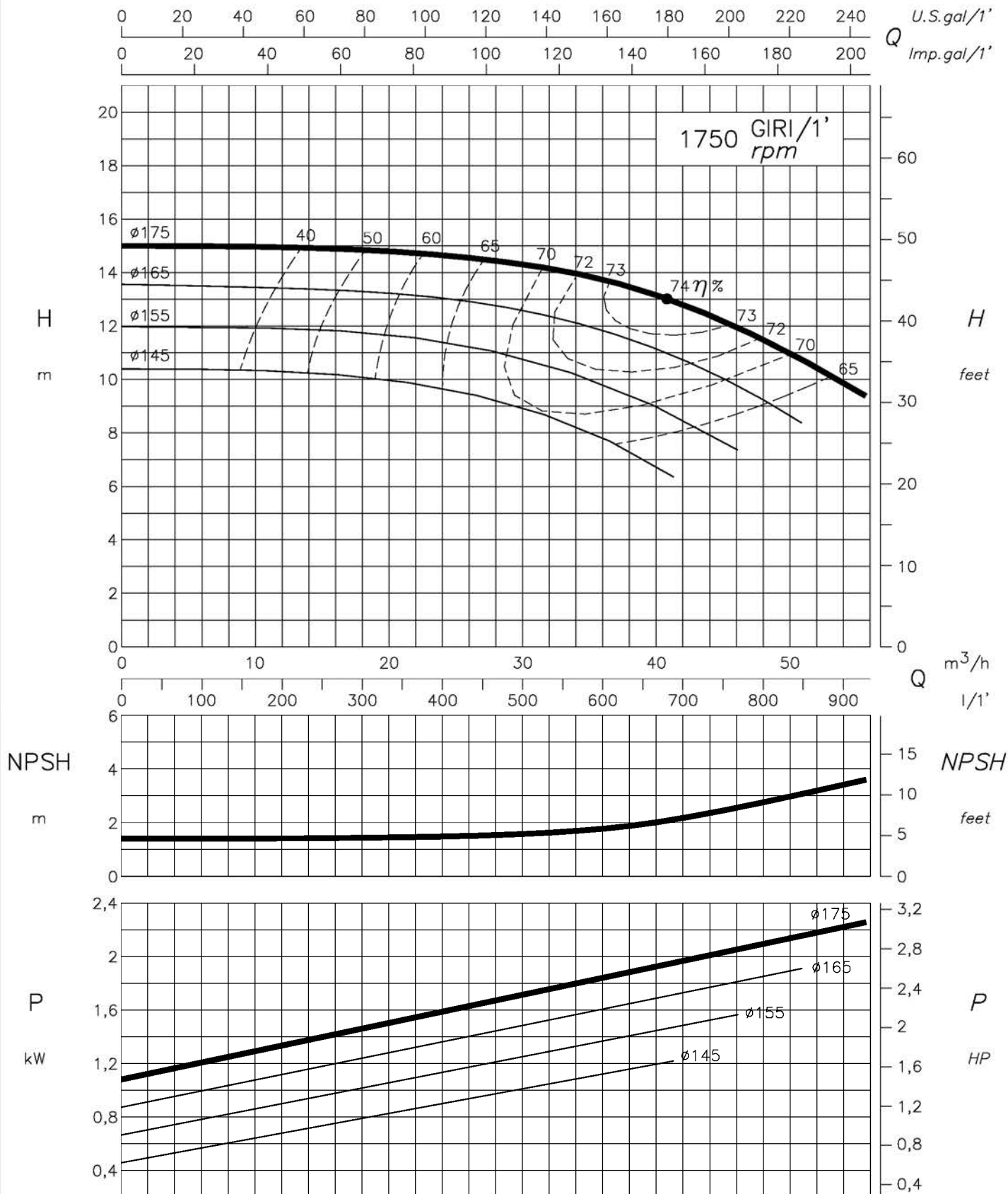

I DATI RIPORTATI SONO RIFERITI A :

Data refers to :
 TEMPERATURA MAX. 30 °C - (86 °F) Max. Temperature
 PESO SPECIFICO 1 Kg/dm³ Specific gravity
 VISCOSITA' 1 cP Viscosity

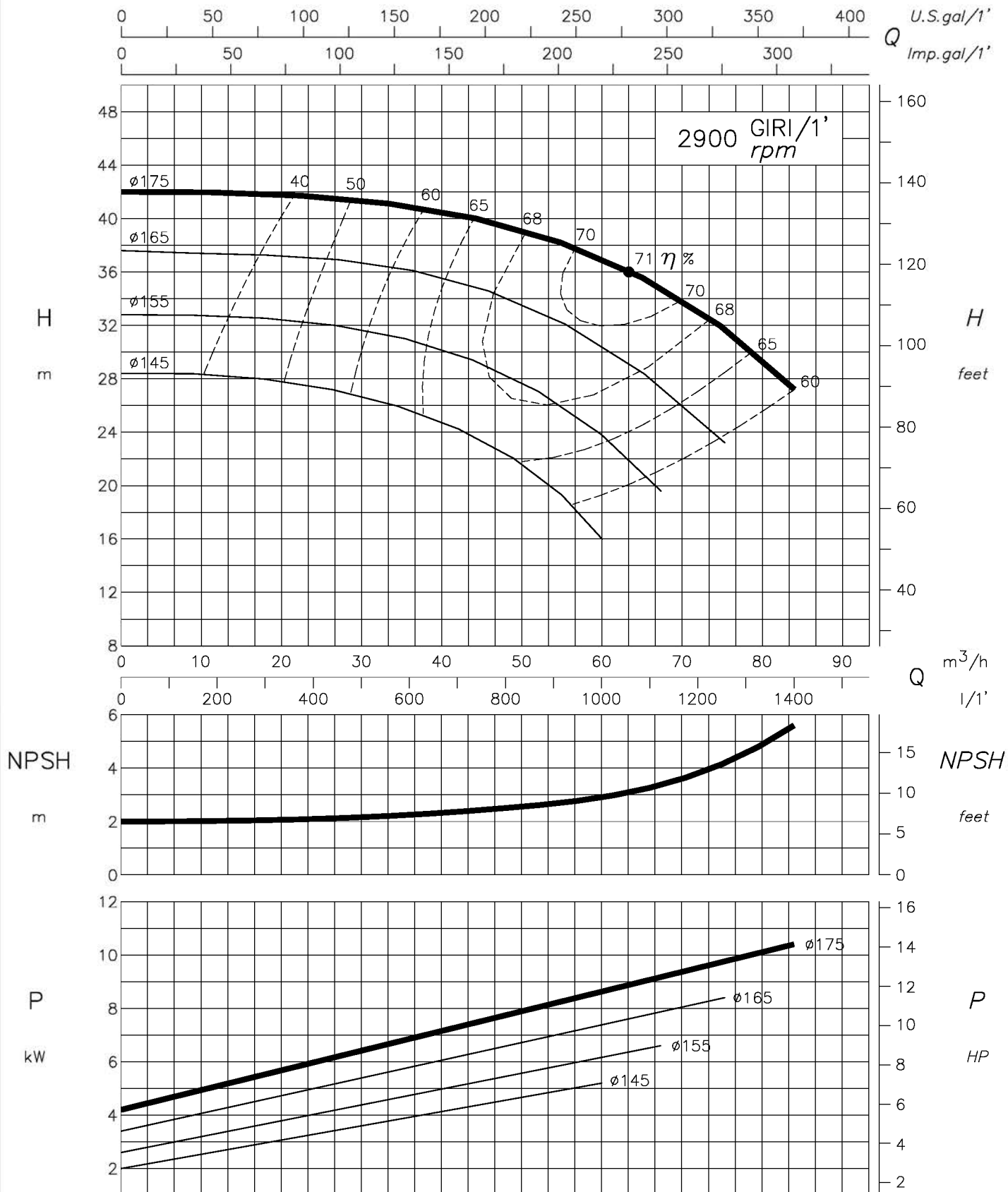



I DATI RIPORTATI SONO RIFERITI A :

Data refers to :
 TEMPERATURA MAX. 30 °C - (86 °F) Max. Temperature
 PESO SPECIFICO 1 Kg/dm³ Specific gravity
 VISCOSITA' 1 cP Viscosity

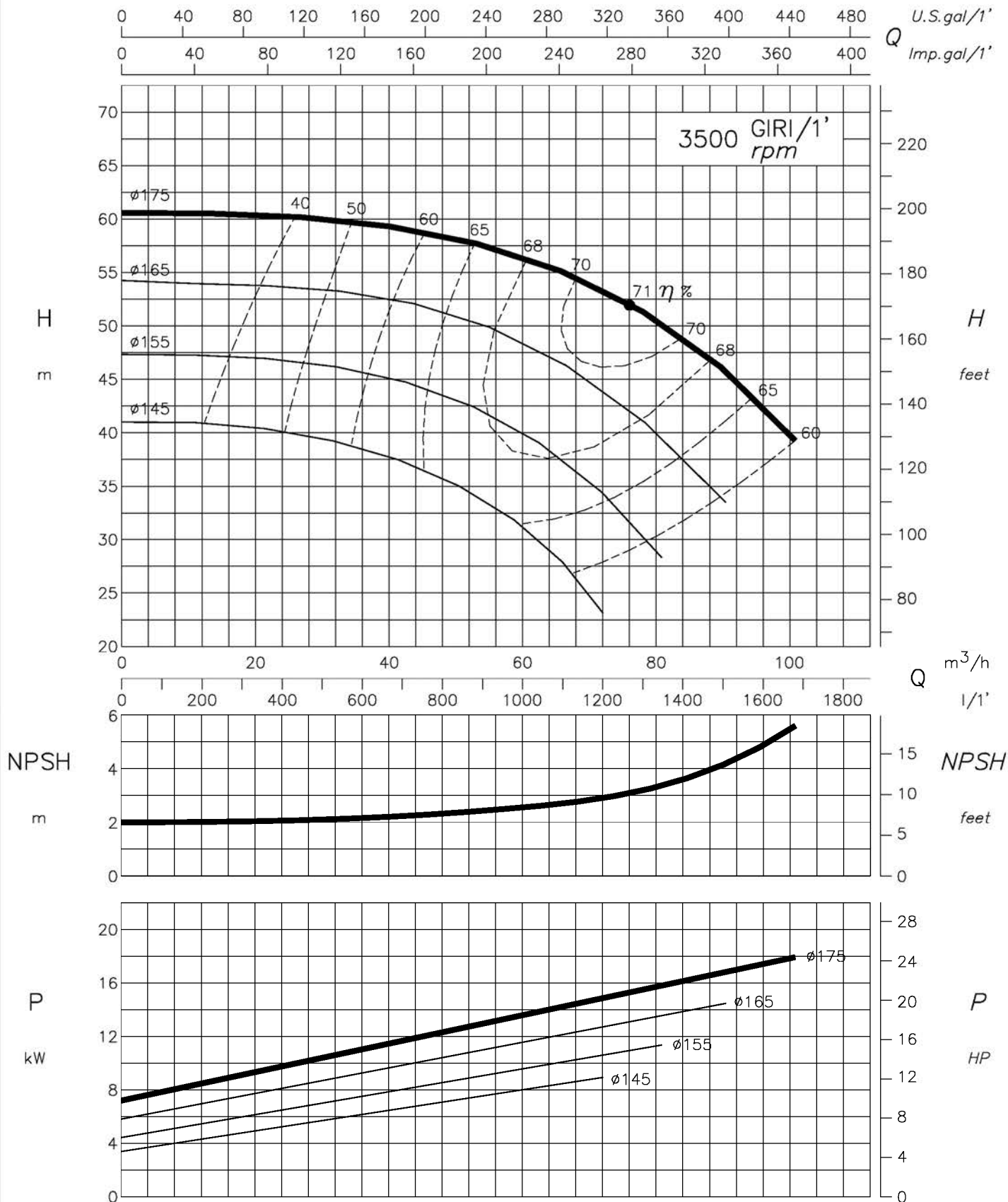



I DATI RIPORTATI SONO RIFERITI A :

Data refers to :
 TEMPERATURA MAX. 30 °C - (86 °F) Max. Temperature
 PESO SPECIFICO 1 Kg/dm³ Specific gravity
 VISCOSITA' 1 cP Viscosity

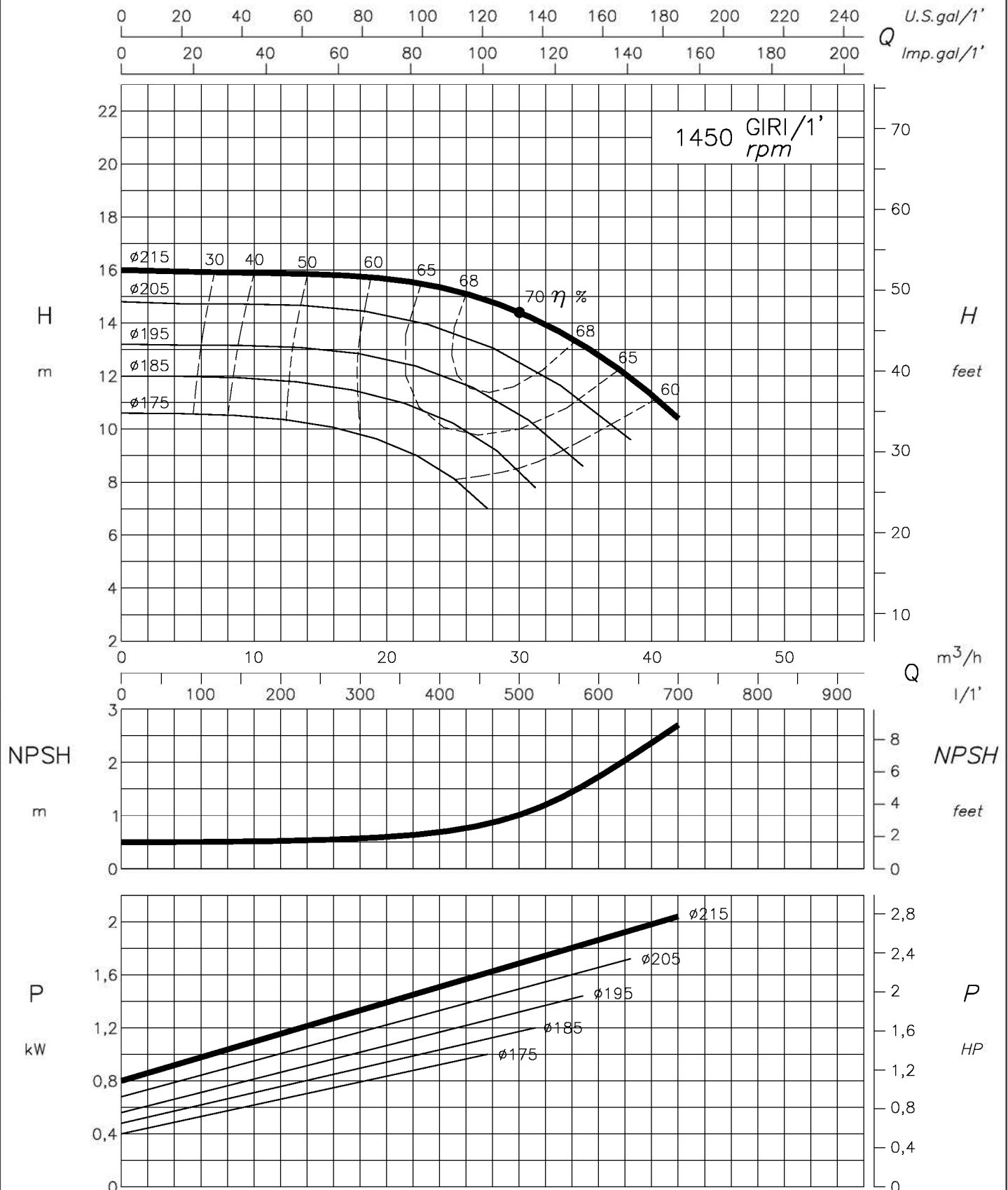



I DATI RIPORTATI SONO RIFERITI A :

Data refers to :
 TEMPERATURA MAX. 30 °C - (86 °F) Max. Temperature
 PESO SPECIFICO 1 Kg/dm³ Specific gravity
 VISCOSITA' 1 cP Viscosity

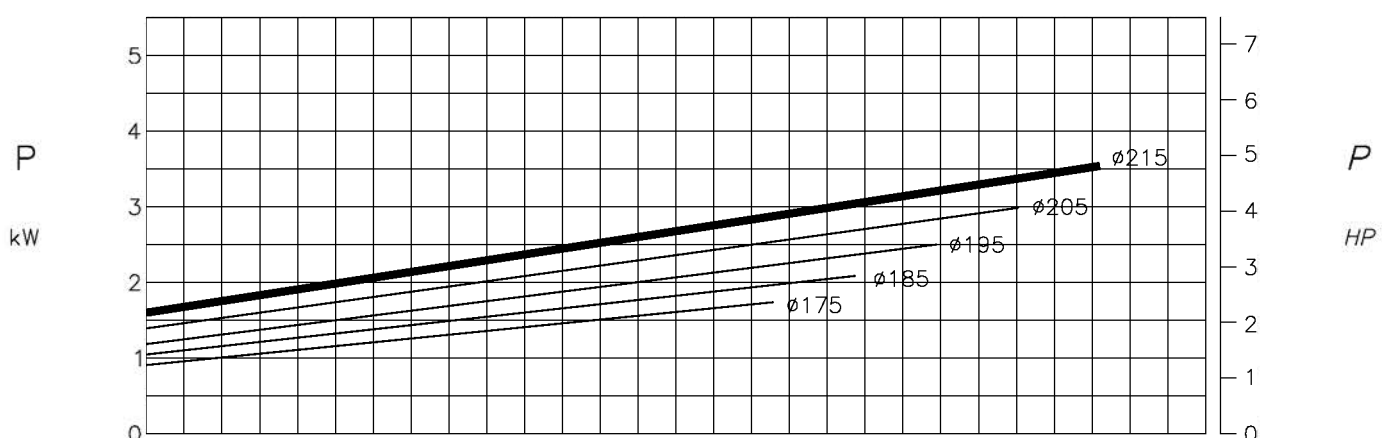
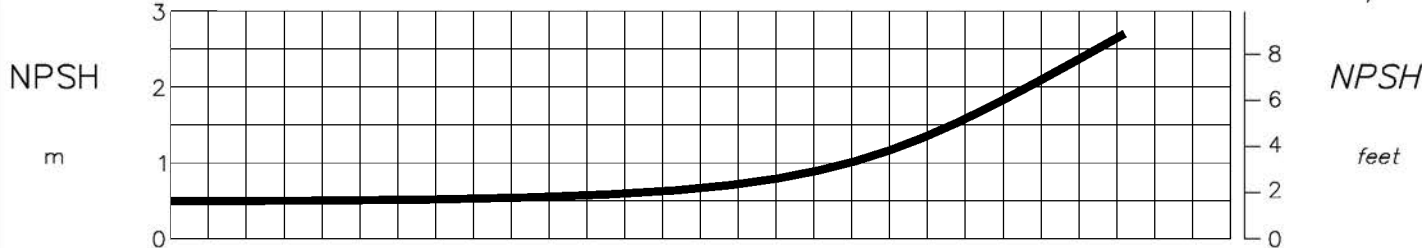
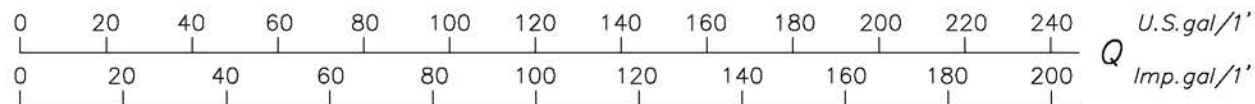



I DATI RIPORTATI SONO RIFERITI A :

Data refers to :
 TEMPERATURA MAX. 30 °C - (86 °F) Max. Temperature
 PESO SPECIFICO 1 Kg/dm³ Specific gravity
 VISCOSITA' 1 °E Viscosity

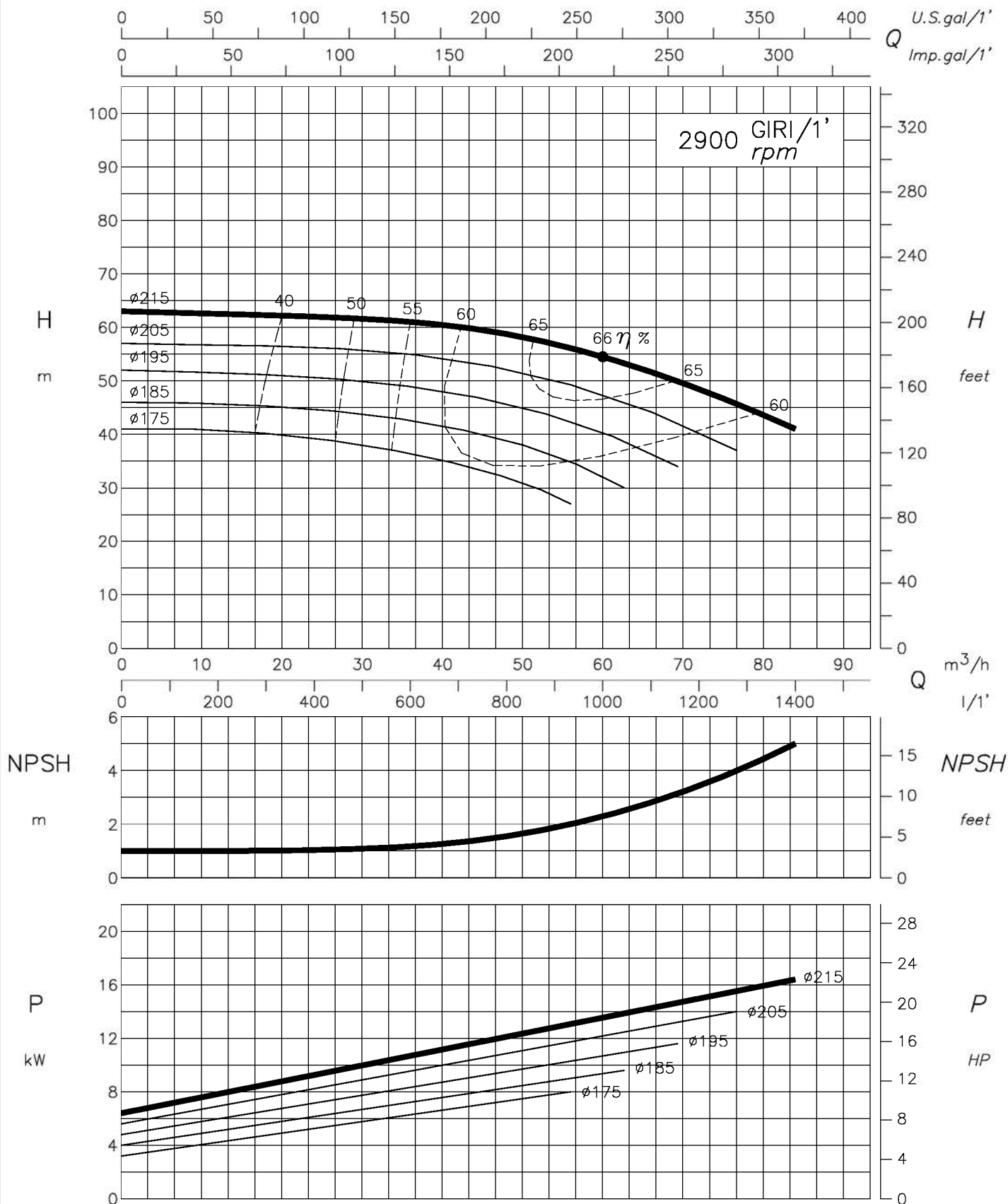



I DATI RIPORTATI SONO RIFERITI A :

Data refers to :

TEMPERATURA MAX. 30 °C - (86 °F) Max. Temperature
 PESO SPECIFICO 1 Kg/dm³ Specific gravity
 VISCOSITA' 1 cP Viscosity

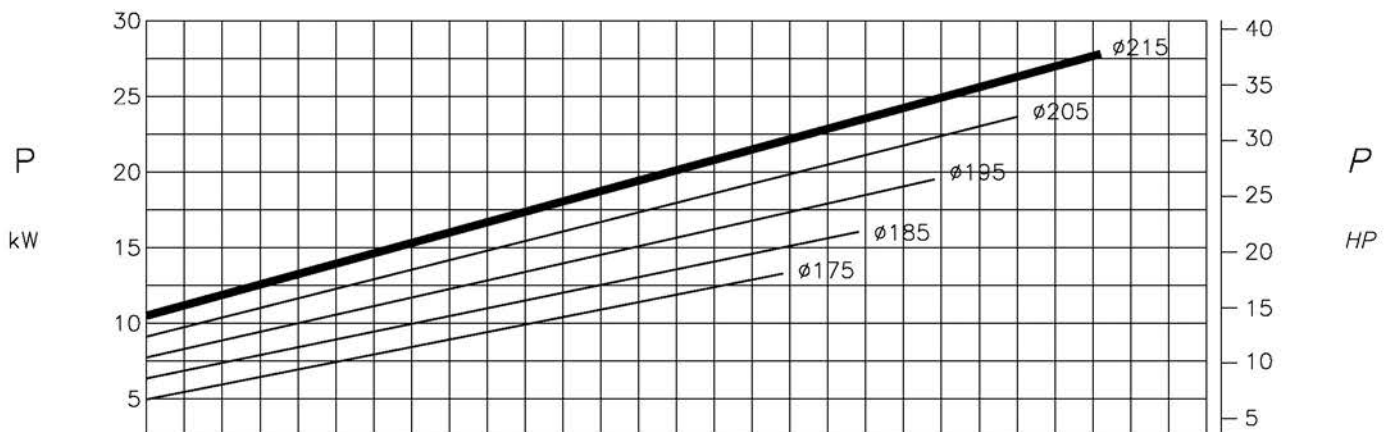
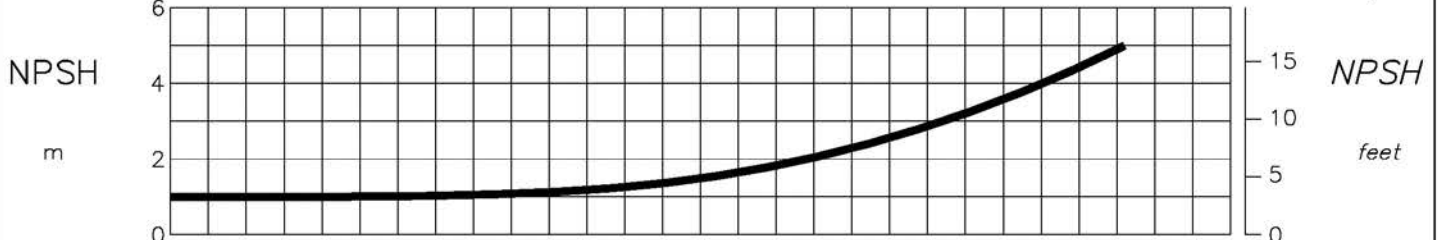
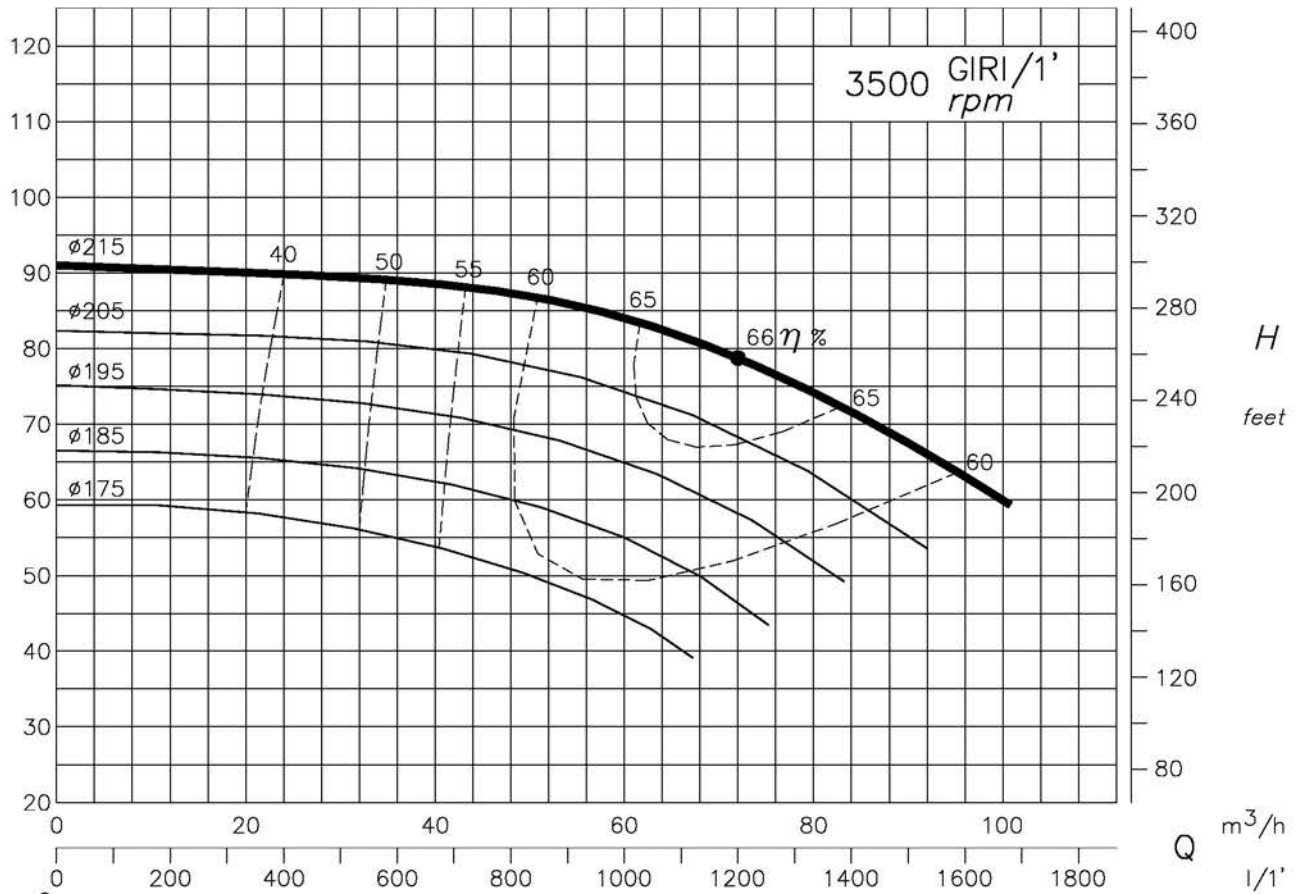
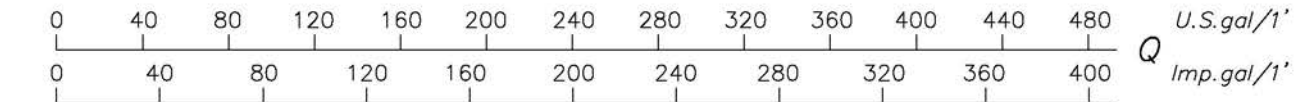



I DATI RIPORTATI SONO RIFERITI A :

Data refers to :
 TEMPERATURA MAX. 30 °C - (86 °F) Max. Temperature
 PESO SPECIFICO 1 Kg/dm³ Specific gravity
 VISCOSITA' 1 ªE Viscosity



DIAGRAMMA DI FUNZIONAMENTO
 Performance curves
 POMPA CENTRIFUGA MONOSTADIO
 Monostage centrifugal pump

TIPO
 Type

TCD 50-250

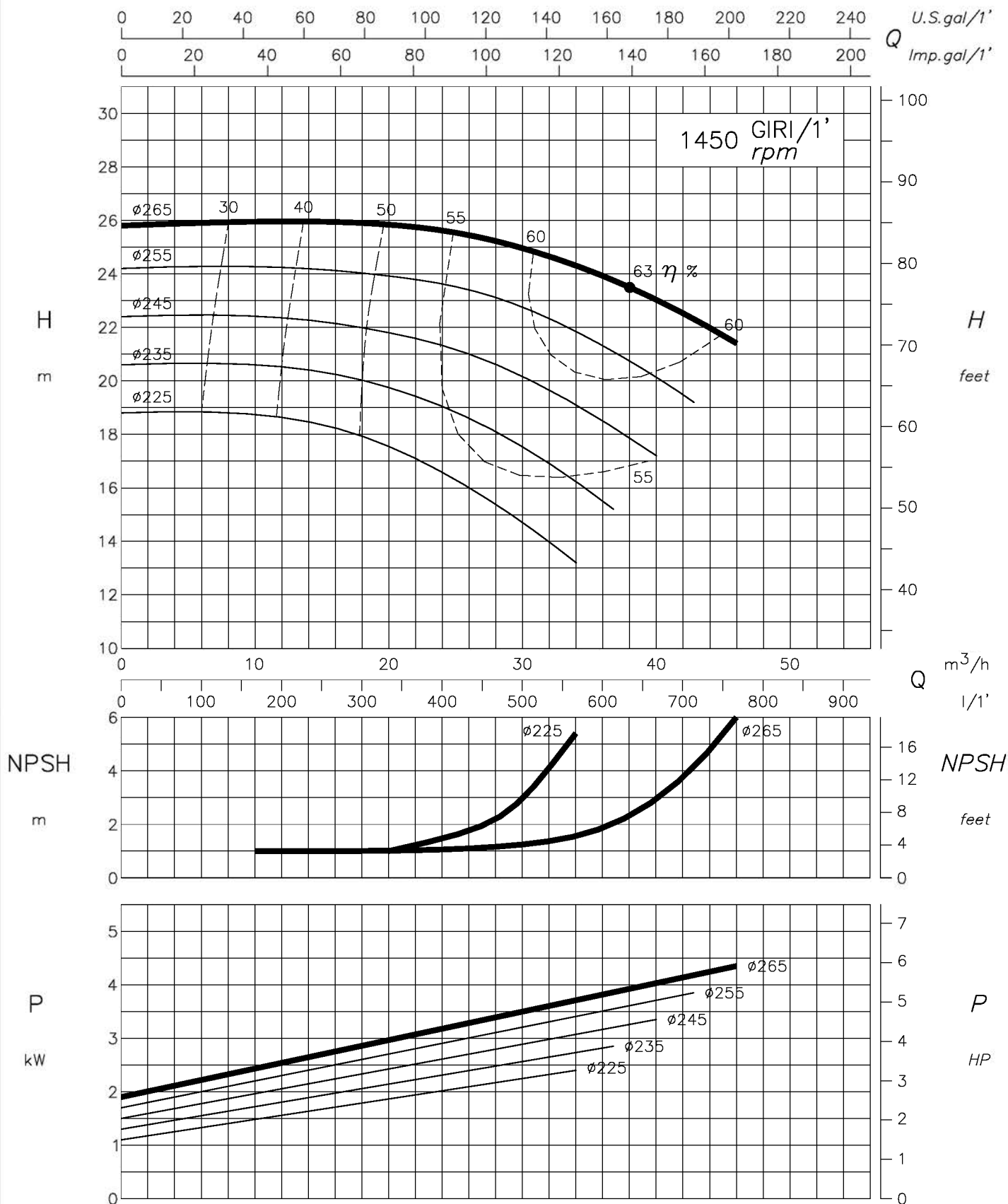

**TRAVAINI
 PUMPS USA**
 Liquid Ring & Rotary Vane Vacuum Pumps and Systems

200 Newsome Drive
 Yorktown, VA 23693
 1-800-535-4243
 www.Travaini.com

I DATI RIPORTATI SONO RIFERITI A :

Data refers to :

TEMPERATURA MAX.	30 °C - (86 °F)	Max. Temperature
PESO SPECIFICO	1 Kg/dm ³	Specific gravity
VISCOSITA'	1 °E	Viscosity

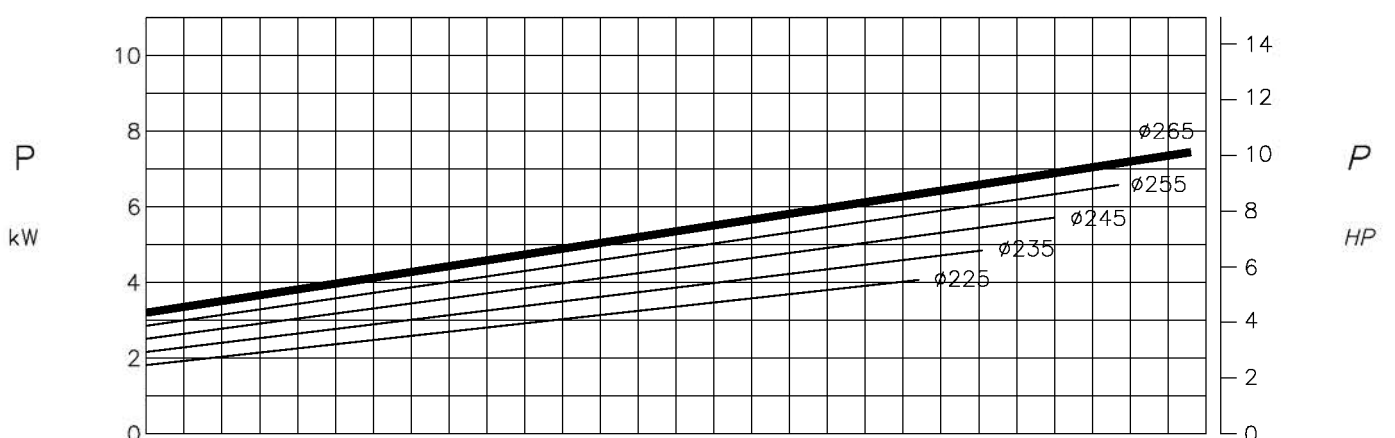
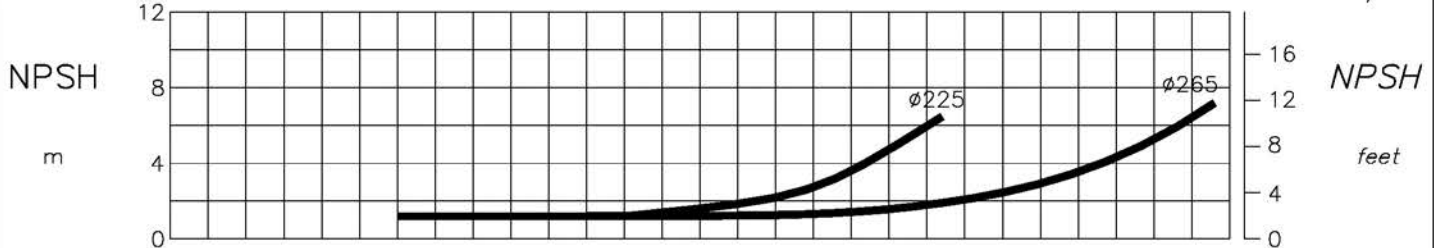
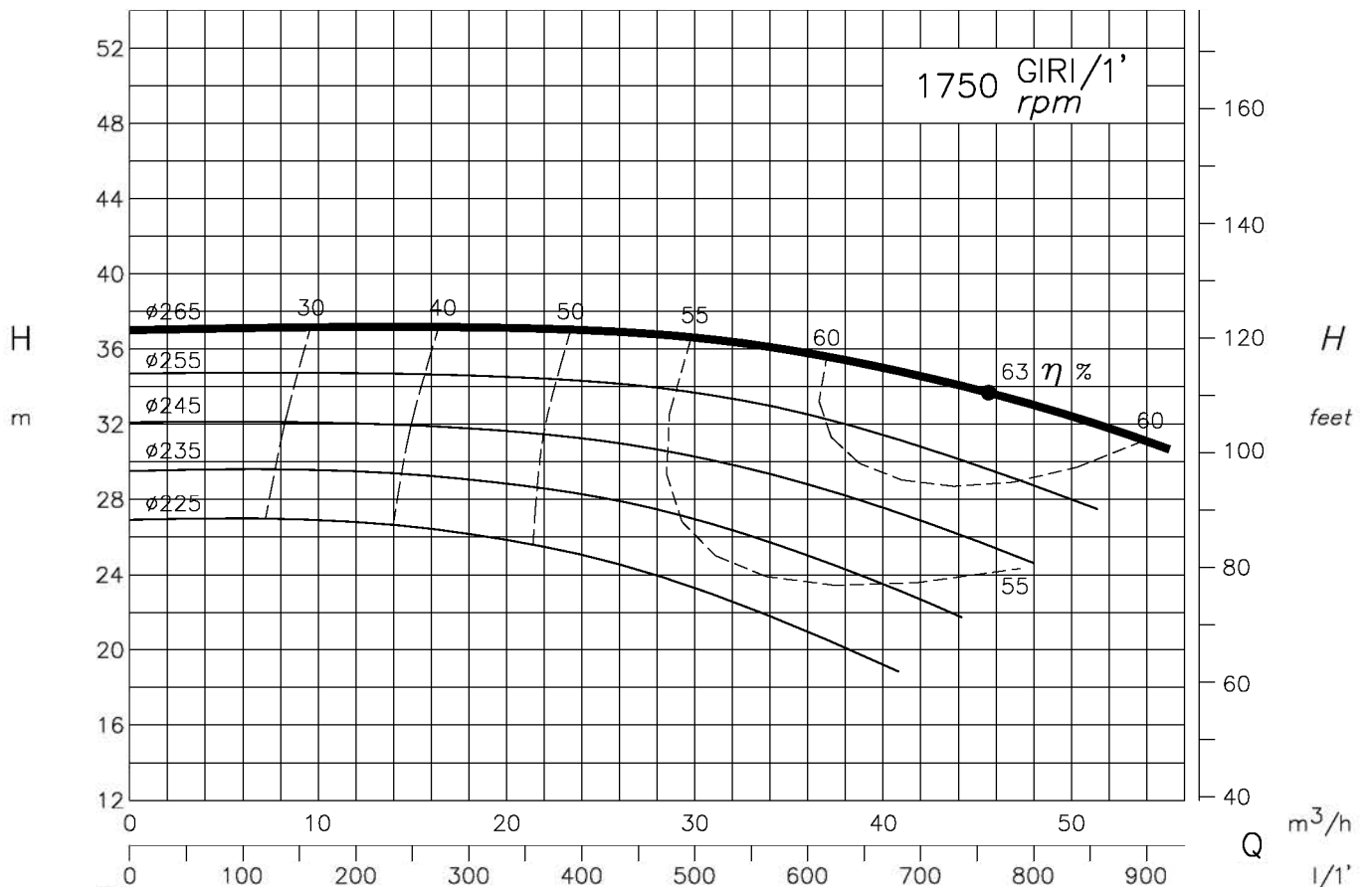
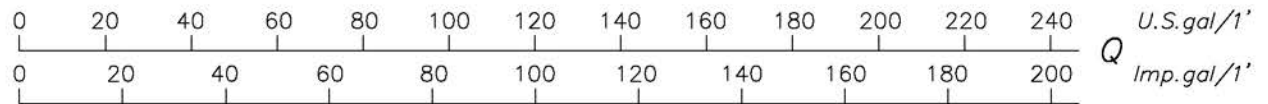



I DATI RIPORTATI SONO RIFERITI A :

Data refers to :

TEMPERATURA MAX. 30 °C - (86 °F) Max. Temperature
 PESO SPECIFICO 1 Kg/dm³ Specific gravity
 VISCOSITA' 1 °E Viscosity

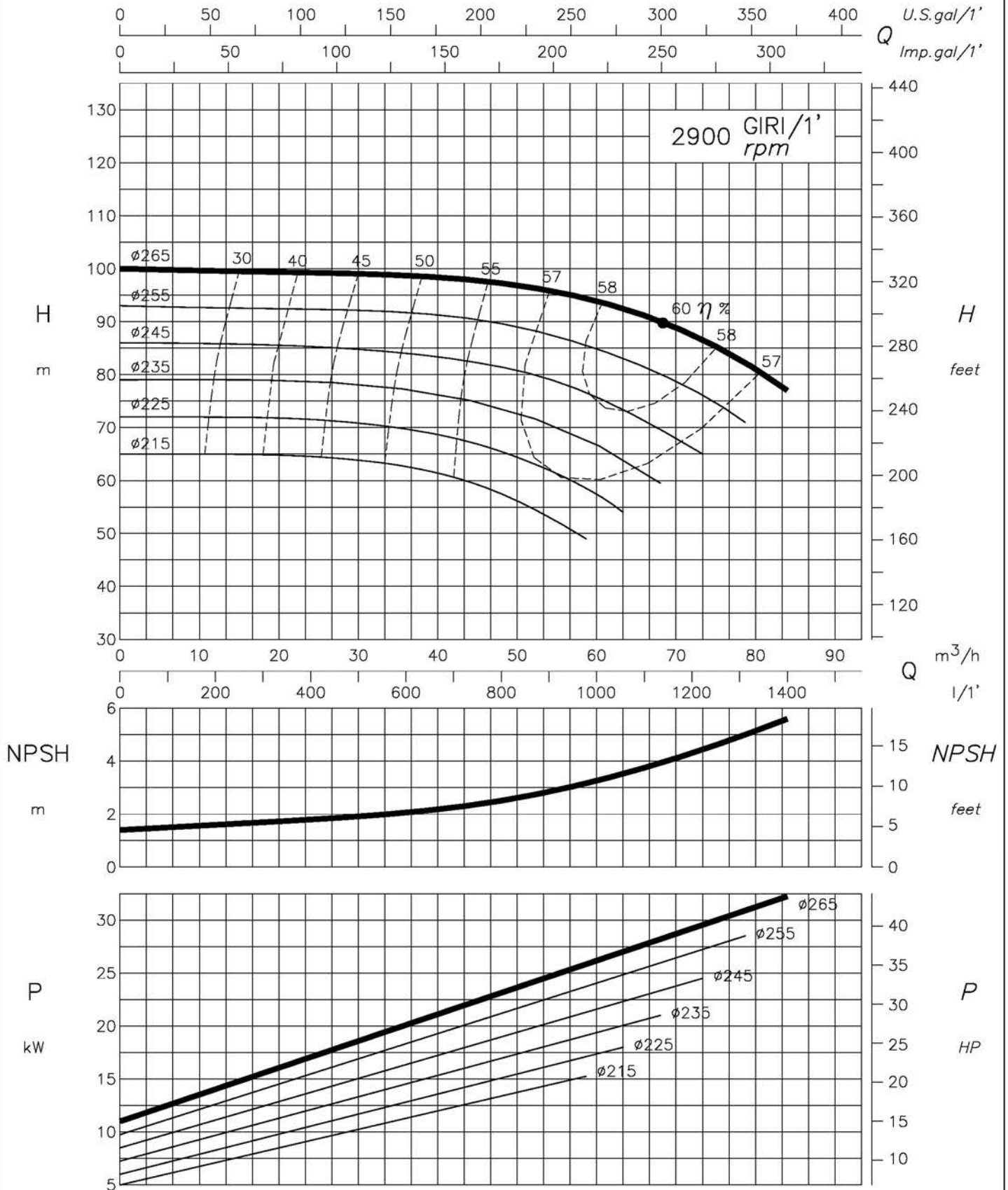



I DATI RIPORTATI SONO RIFERITI A :

Data refers to :
 TEMPERATURA MAX. 30 °C - (86 °F) Max. Temperature
 PESO SPECIFICO 1 Kg/dm³ Specific gravity
 VISCOSITA' 1 °E Viscosity

